

ASSEMBLY INSTRUCTION

Korfu Module Corner Sofa, Nature, Bamboo
82051106



ASSEMBLY INSTRUCTION

Korfu Module Corner Sofa, Nature, Bamboo
82051106

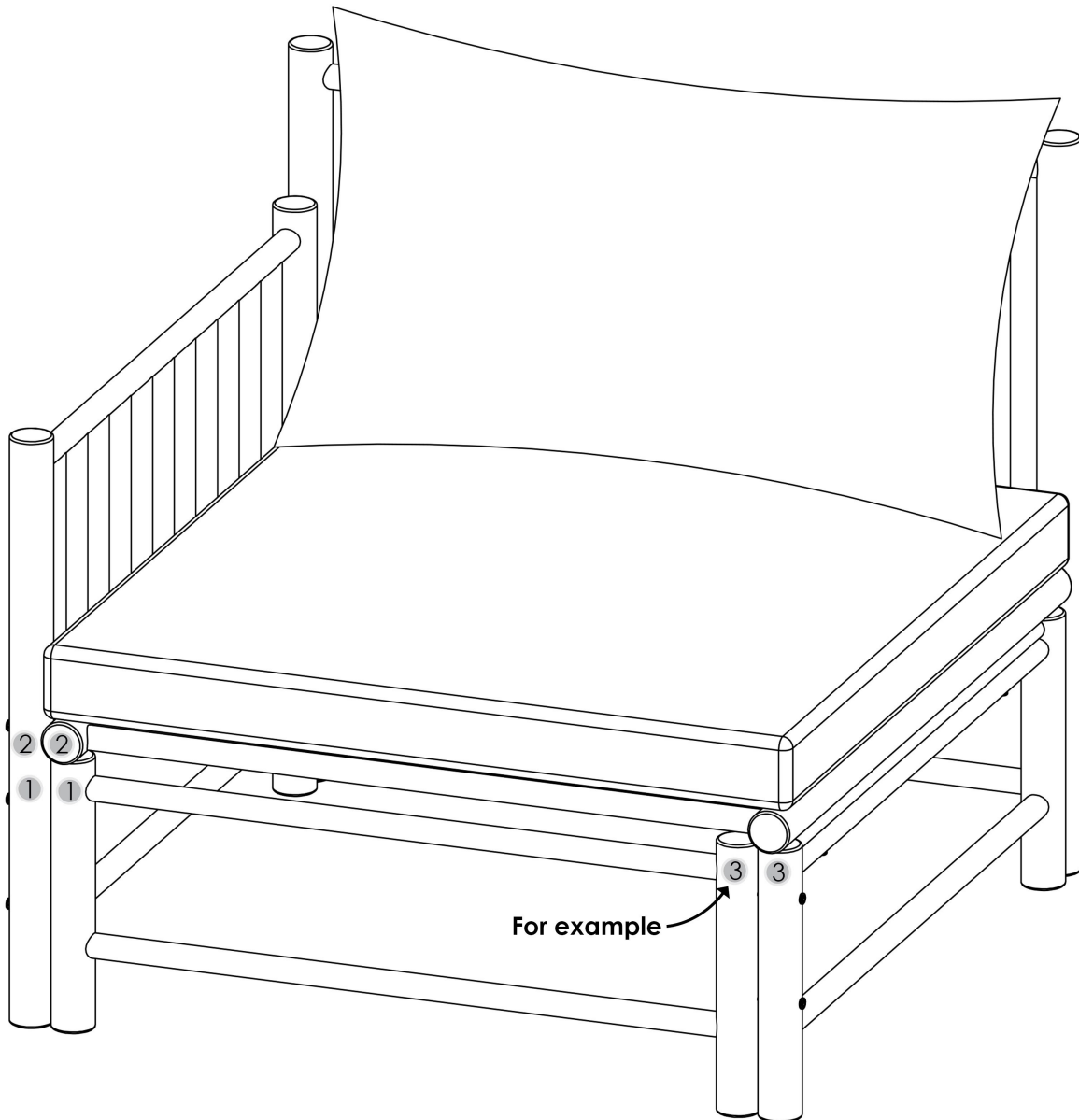

All products are handmade, therefore always follow the number instructions on the furniture.

***Bloomingville**[®]
EVER CHANGING HOMES

Component list

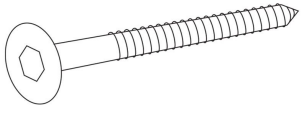

M7x70 | 12 pcs

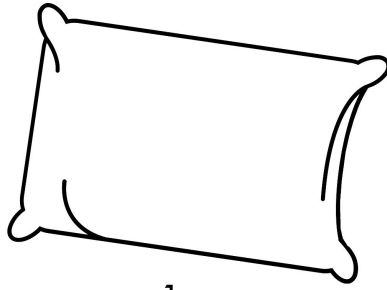

1 pc



1 pc

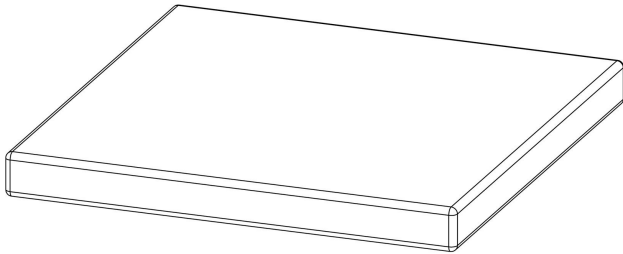

1 pc

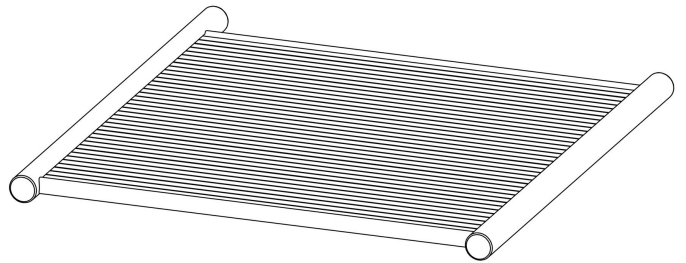

1 pc

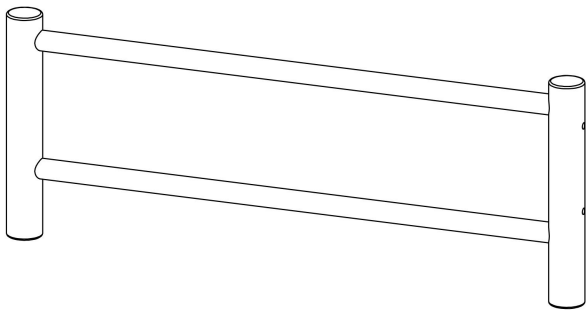

1 pc

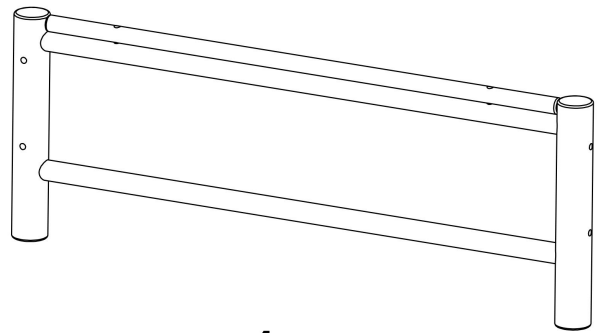

1 pc

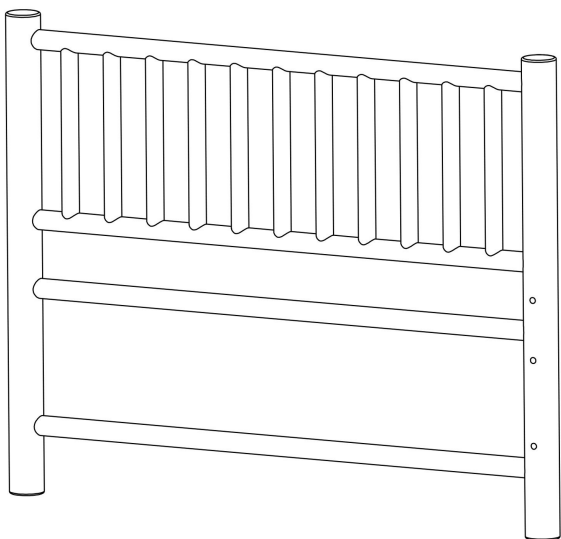

1 pc

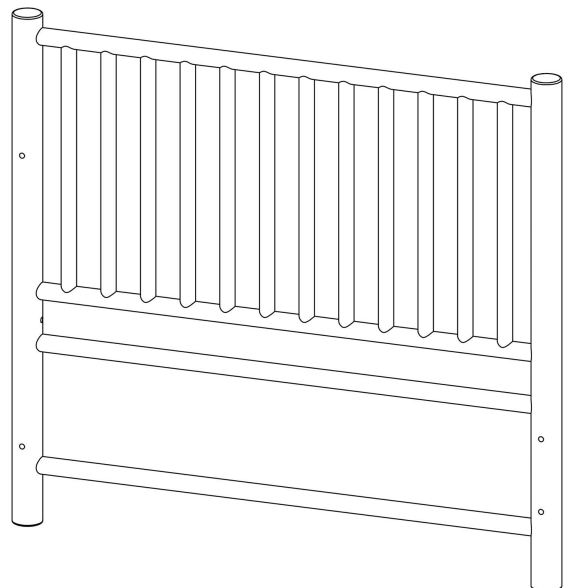

1 pc

INSTRUCTION

Step 1

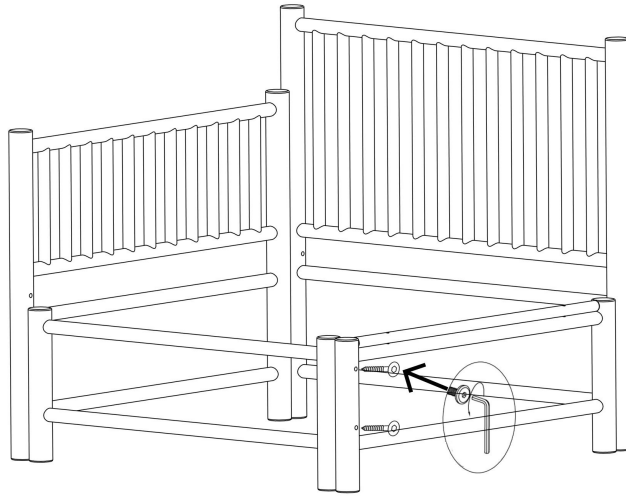

Step 2

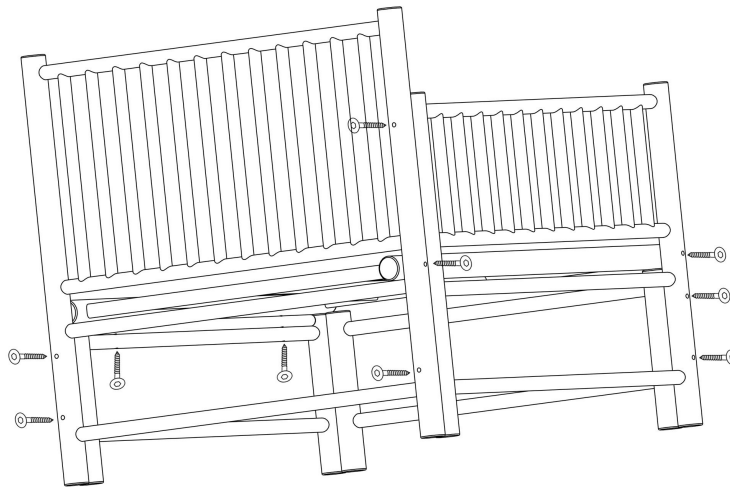

Step 3

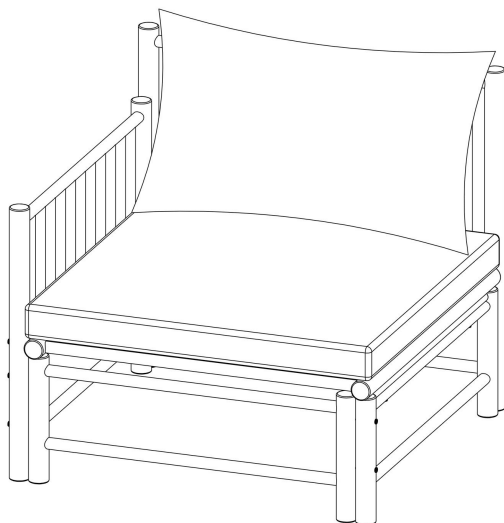

Finished

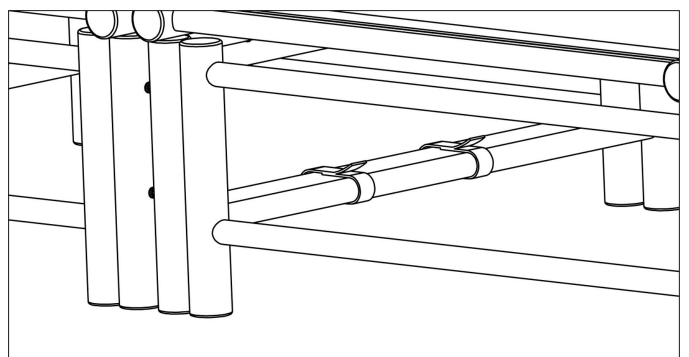

Optional

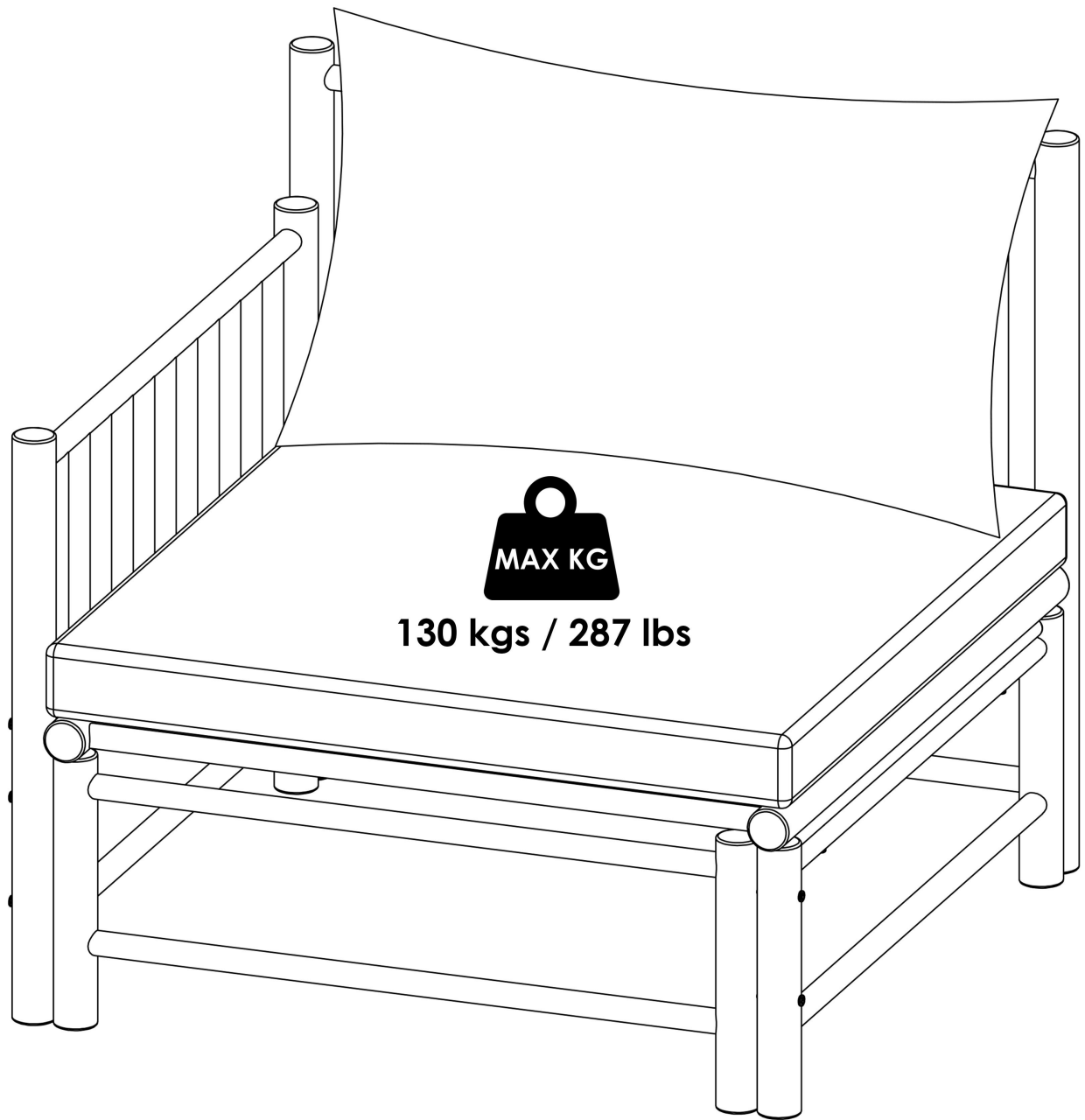

Congratulations on your new bamboo furniture!

Bamboo is a natural material and must be handled with care. These tips can help you preserve the lifespan of your furniture. During wet and cold seasons, the furniture must be stored in a dry and well-ventilated place. Over time the bamboo furniture can develop mold on the surface. We recommend that you place the furniture in covered and dry areas to reduce exposure to water and moist. When leaving bamboo furniture outdoors, the bamboo will naturally absorb dust and dirt and its color may change to grey. It is possible to reduce the discoloration by regularly washing the furniture with a moist cloth and rub in tested furniture oil. Another option is to paint the furniture with strong outdoor varnish before putting it to use. We care for a greener future and sharing our bamboo love.

Enjoy!

***Bloomingville**[®]
-EVER CHANGING HOMES