

# Salve

# SIT SIT outdoor

## Modules

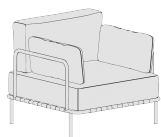

Armchair



Pouf  
module

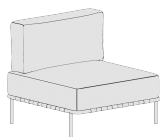

Single  
module

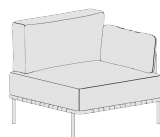

End  
module

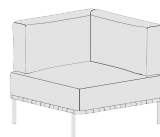

Corner  
module

## Layouts

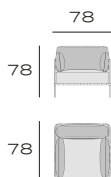

Armchair

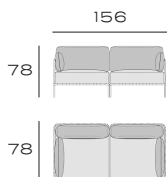

2 -seater

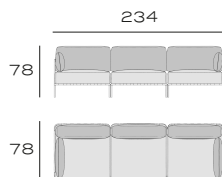

3-seater

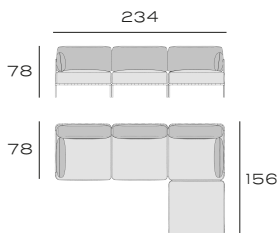



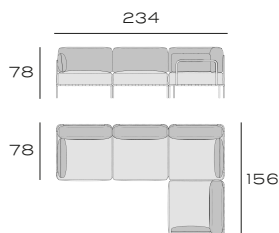





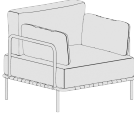

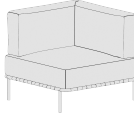
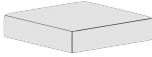

4-seater,  
corner\_1

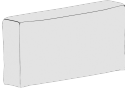

4-seater,  
corner\_2

# Box content

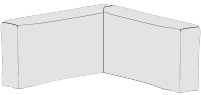
	 Armchair	 Pouf module	 Single module	 End module	 Corner module
	x1	x1	x1	x1	x1
	x1	x1	x1	x1	x1
	x1	-	x1	x1	-
	x2	-	-	x1	-
	x1	-	x1	x1	x2
	x2	-	-	x1	-
	x6	-	x2	x4	x4
	x2	x2	x2	x2	x2
	x1	-	x1	x1	x1
	-	-	-	-	x1

# Assembly instruction

## End module

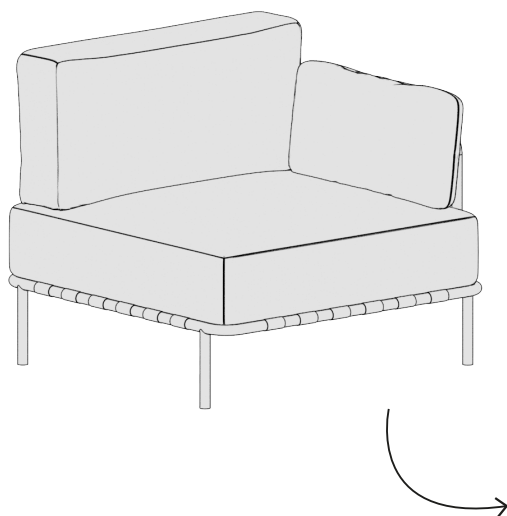

# Assembly instruction

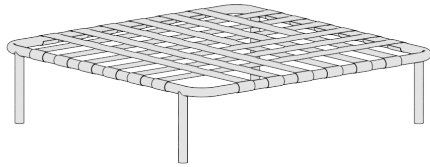

1.

+

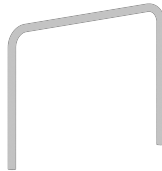

x1



x1

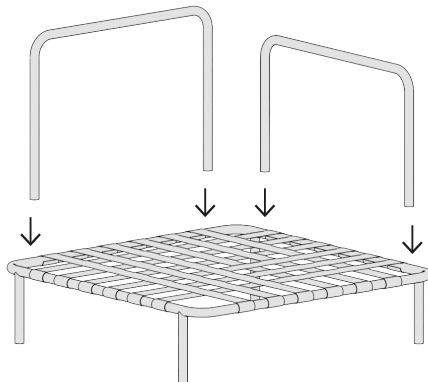

# Assembly instruction

2.

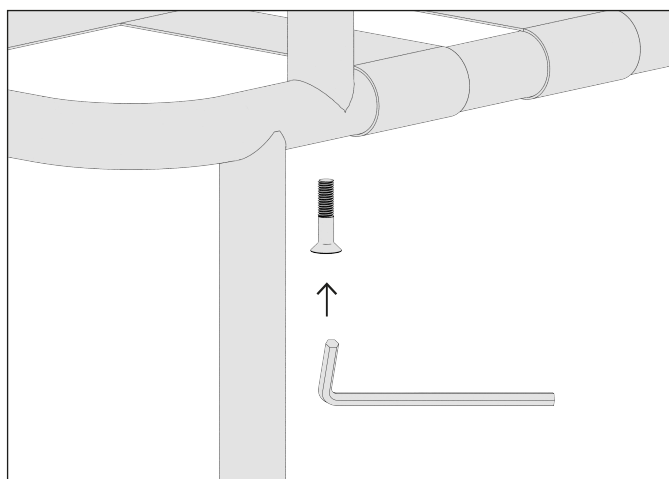
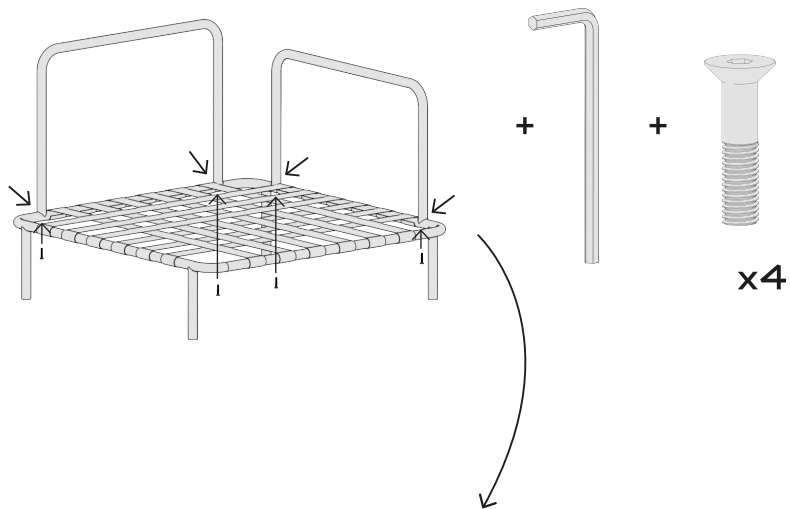

# Assembly instruction

3.

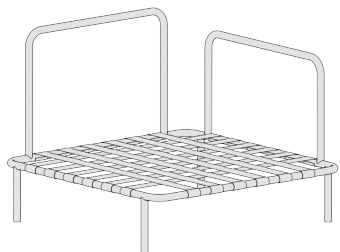

+

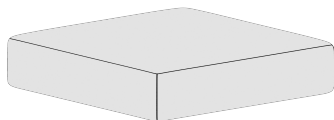

x1

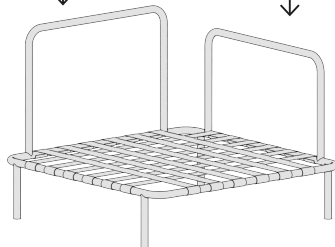
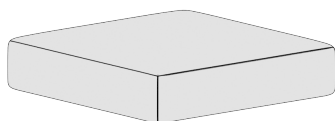

4.

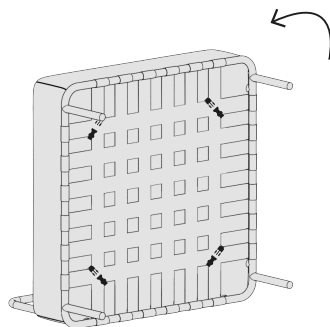
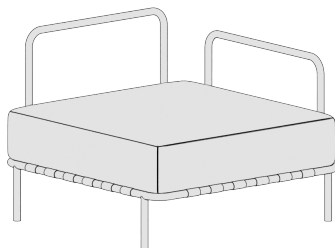

# Assembly instruction

5.

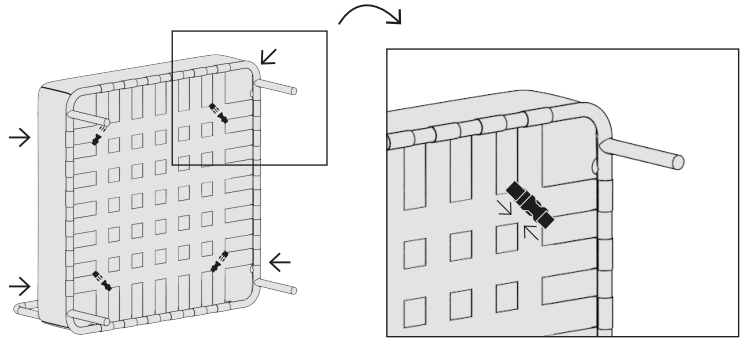

6.

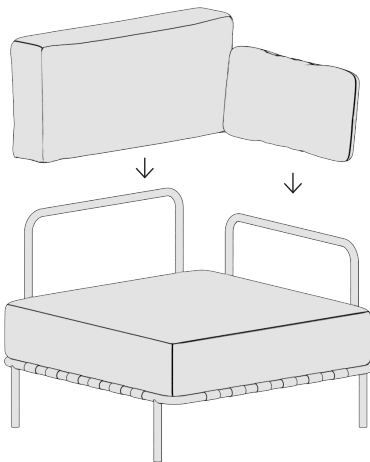
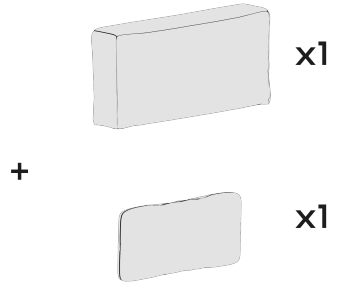
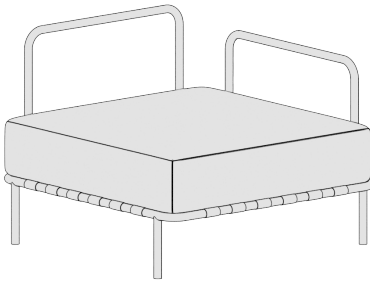

# Good Job!

The SALVE sofa is ready for use!

You can now start creating your own compositions from SALVE modules.

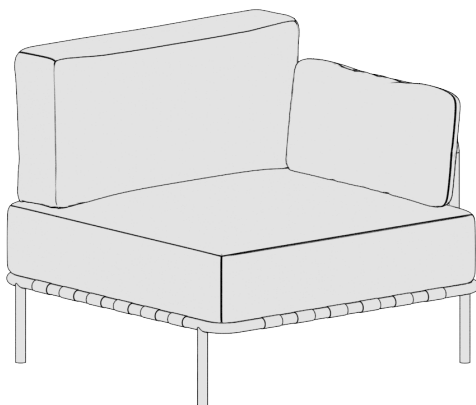

## Connecting modules

