

NOTICE DE MONTAGE
 ASSEMBLY INSTRUCTIONS
 MONTAGEANLEITUNG
 ISTRUZIONI DI MONTAGGIO
 INSTRUÇÕES DE MONTAGEM
 INSTRUCCIONES DE MONTAJE
 UPUTE ZA MONTAZU
 MONTAJ TALIMATI

ME
 marckeric

Enlace Verola S/N
 46430 SOLLANA
 Valencia- España

EAN CODE: 8435178377227 |
 8435178377234

13862 | 13863

LIT SUPERPOSÉ KIARA 90x190

**ESTA CAMA NO ES CONVENIENTE
 PARA NIÑOS MENORES DE 6 AÑOS**

**CE LIT NE CONVIENT PAS AUX
 ENFANTS DE MOINS DE 6 ANS**

**POUR ENFANT CAPABLE D'ENTRER
 ET DE SORTIR SEUL DE SON LIT**

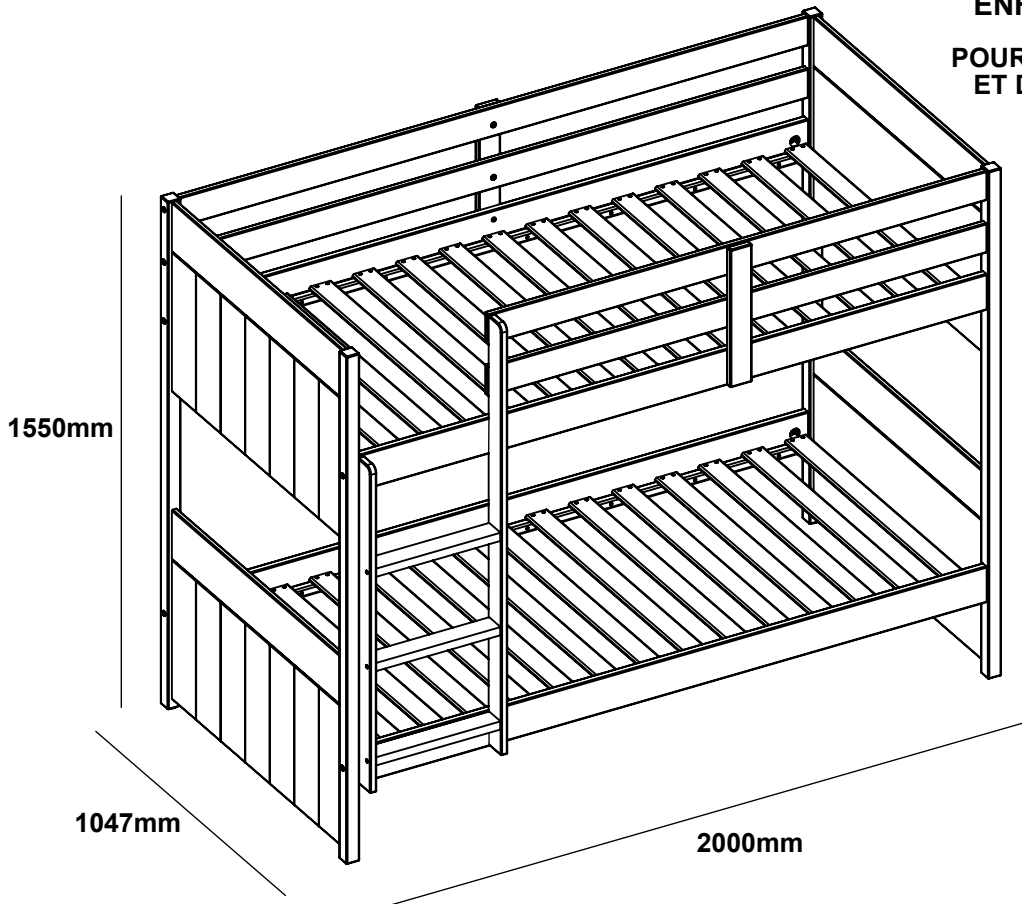

*AVANT DE COMMENCER, SE
 REPORTER AUX CONSEILS
 DE MONTAGE EN ANNEXE*

*BEFORE STARTING, REFER
 TO THE ASSEMBLING ADVICE
 IN ANNEX*

*VOR DIE MONTAGE,
 BEILIEGENDE ANWEISÜGEN
 BEFOLGEN*

*PRIMA DI COMINCIARE
 LEGGETE LE ISTRUZIONI DI
 MONTAGGIO*

*ANTES DE COMEÇAR, ADIAR
 SE AOS CONSELHOS DE
 MONTAGEM EM ANEXO*

*ANTES DE EMPEZAR
 CONSULTE LOS CONSEJOS
 PARA EL MONTAJE*

*PRJE POÇETKA MONTAŽE
 MOLIMO PAŽLJIVO
 PROČITAJTE UPUTE ZA
 MONTAZU*

*BASLAMADAN ÖNCE
 EKTEKI MONTAJ TALIMATLARINI
 INCELEYIMIZ*

À MONTER SOI-MÊME

| Cx | Tamaño de la caja Dimensions colis | Peso bruto Poids brut | Peso neto Poids net |
|-----------|---|----------------------------------|--------------------------------|
| 1/3 | 1620x1030x98 | 35.50kg | 33.50kg |
| 2/3 | 2060x320x95 | 21.50kg | 19.50kg |
| 3/3 | 1920x320x80 | 20kg | 18kg |

IMPORTANT- À CONSERVER POUR RÉFÉRENCE ULTÉRIEURE. LIRE ATTENTIVEMENT

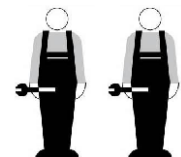
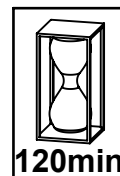
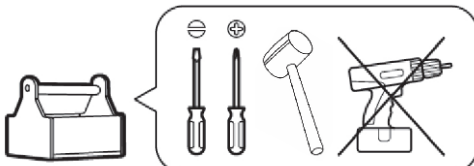

INSTRUCTIONS D'UTILISATION

IMPORTANT - LIRE ATTENTIVEMENT - A CONSERVER POUR RÉFÉRENCE ULTÉRIEURE

- a) **AVERTISSEMENT** - Les lits surélevés et le lit supérieur des lits superposés ne conviennent pas pour les enfants de moins de six ans en raison du risque de blessures liées à des chutes.
- b) **AVERTISSEMENT** - S'ils ne sont pas utilisés correctement, les lits superposés et les lits surélevés peuvent présenter un sérieux risque de blessure par étranglement. Ne jamais attacher ou suspendre des éléments à des parties du lit superposé qui ne sont pas destinés à être utilisés avec ledit lit. Ces éléments comprennent, sans toutefois s'y limiter, les cordes, les ficelles, les cordons, les crochets, les ceintures et les sacs.
- c) **AVERTISSEMENT** - Les enfants peuvent se retrouver coincés entre le lit et un mur, une partie d'un toit incliné, le plafond, des meubles adjacents (par exemple, des placards) ou autre. Pour éviter tout risque de blessure grave, la distance entre la barrière de sécurité supérieure et les éléments environnants ne doit pas dépasser 75 mm ou doit être supérieure à 230mm.
- d) **AVERTISSEMENT** - Ne pas utiliser le lit superposé ou le lit surélevé si une pièce de la structure est manquante ou cassée. Les pièces de rechange doivent être demandées auprès du fabricant ou du magasin.
- e) Il est impératif de toujours suivre les instructions de montage et d'utilisation du fabricant.
- f) La taille recommandée du matelas à utiliser avec le lit est de 192x92 cm , **Epaisseur du matelas maximum: 220mm**
- g) Il est nécessaire de ventiler la pièce afin de maintenir un niveau peu élevé d'humidité et d'empêcher le développement de moisissure dans le lit et sa périphérie.
- h) Les dispositifs d'assemblage doivent toujours être convenablement serrés et régulièrement vérifiés. les resserrer si nécessaire.
- i) Conforme aux exigences européenne de sécurité de la norme NF EN 747 + A1 : 2015.

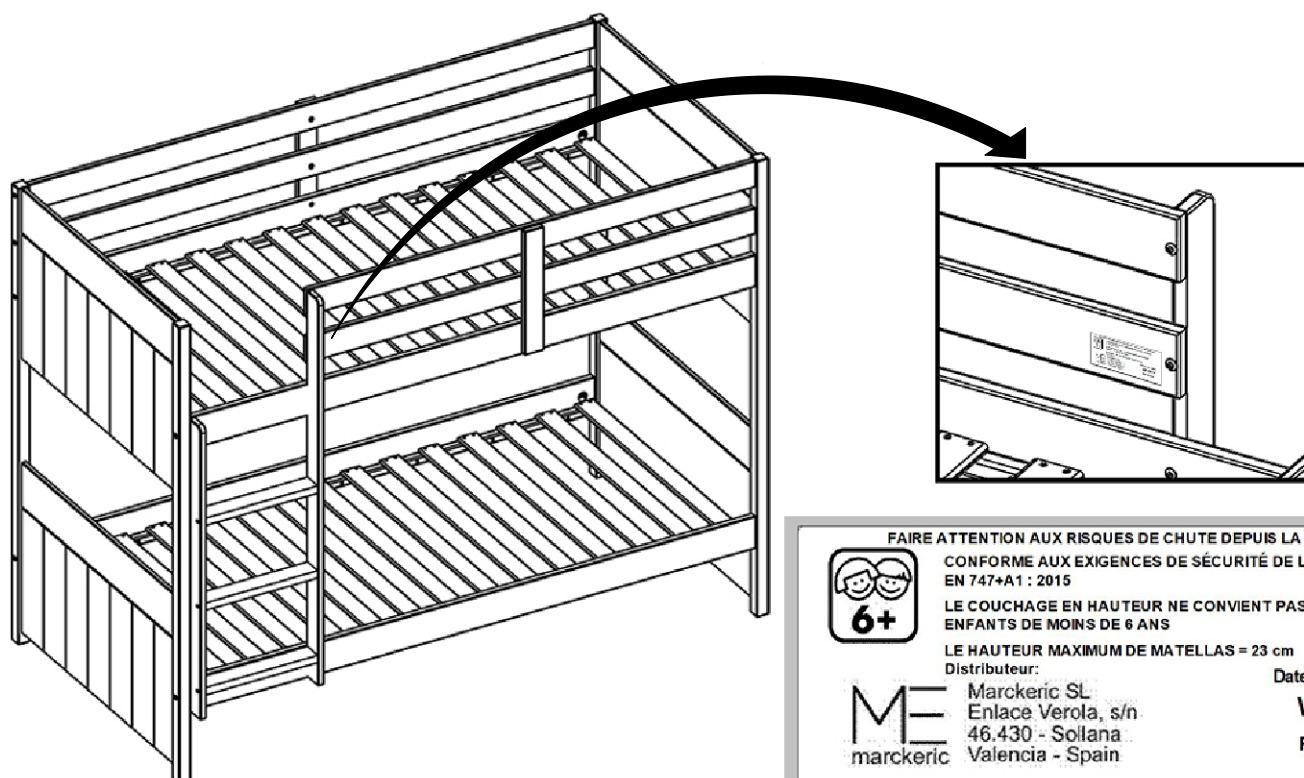



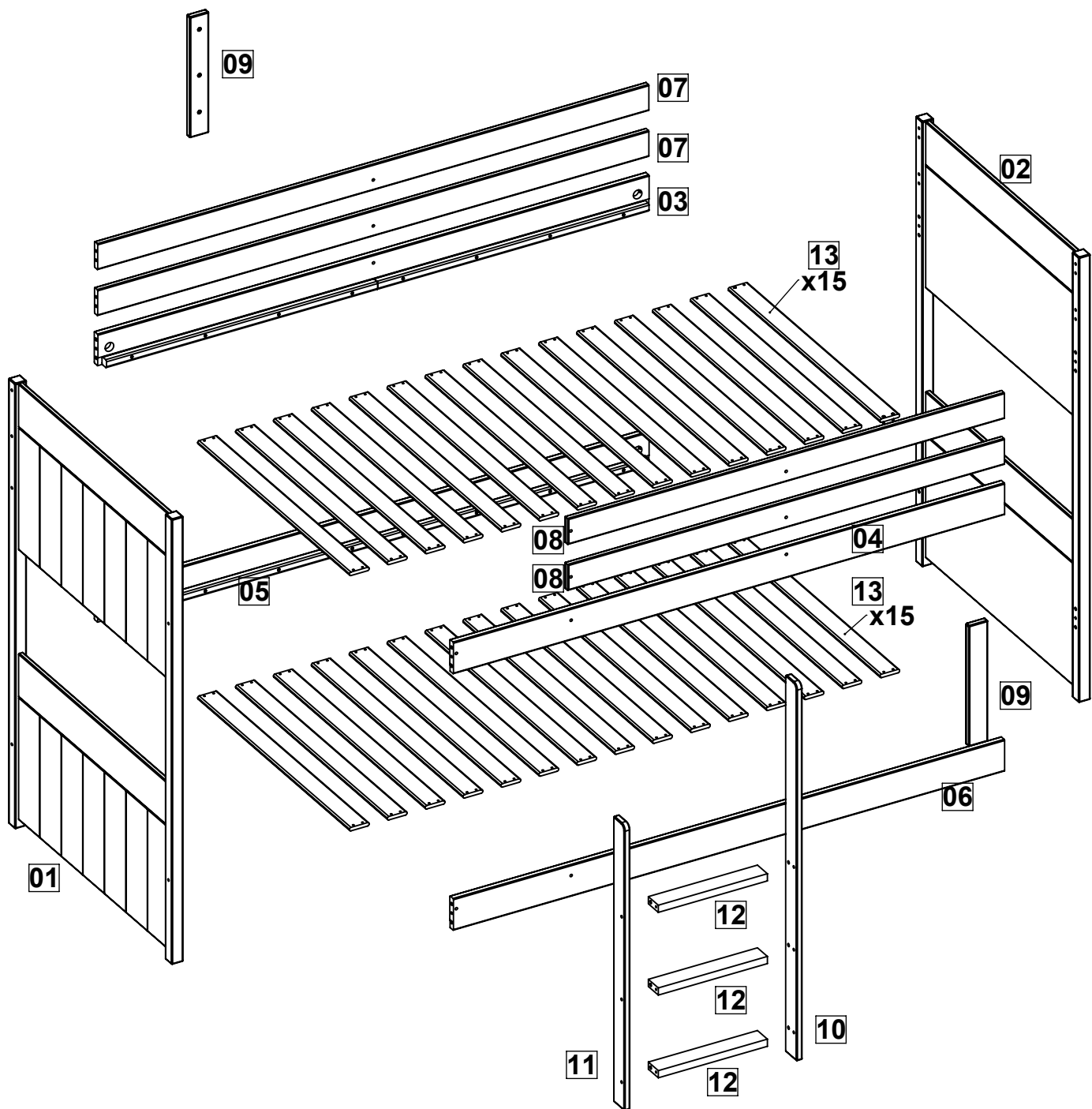



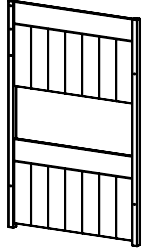
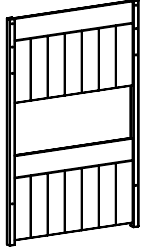

FAIRE ATTENTION AUX RISQUES DE CHUTE DEPUIS LA PLATEFORME
CONFORME AUX EXIGENCES DE SÉCURITÉ DE LA NORME:
EN 747+A1 : 2015
LE COUCHAGE EN HAUTEUR NE CONVIENT PAS À DES
ENFANTS DE MOINS DE 6 ANS
LE HAUTEUR MAXIMUM DE MATELLAS = 23 cm
Distributeur:
ME Marckeric SL
Enlace Verola, s/n
46.430 - Sollana
Valencia - Spain
Date de fabrication:
W11/2020
REF: 04.406





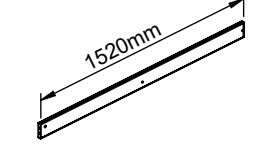

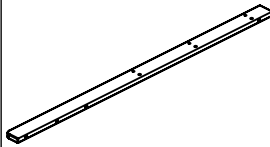
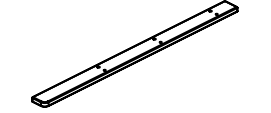
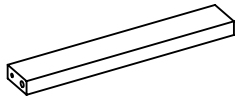
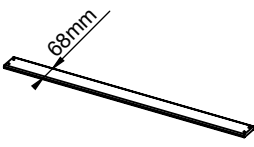





| CAJA/CAISE 1/3 | CAJA/CAISE 2/3 | CAJA/CAISE 3/3 |
|------------------------------------|----------------|----------------|
| 1x PIECES 01 | 1x PIECES 06 | 1x PIECES 04 |
| 1x PIECES 02 | 1x PIECES 05 | 1x PIECES 03 |
| 3x PIECES 12 | 30x PIECES 13 | 2x PIECES 07 |
| 2x PIECES 09 | | 2x PIECES 08 |
| | | 1x PIECES 11 |
| | | 1x PIECES 10 |
| HOJA DE MONTAJE+ HERRAJES | | |
| NOTICE DE MONTAGE+ QUINCALLARIE | | |

LISTADO DE PIEZAS - COMPOSANTS - PARTS LIST

| | | | | | | | | |
|----|---|------|----|---|------|----|---|------|
| 01 |  | 01pc | 02 |  | 01pc | 03 |  | 01pc |
| 04 |  | 01pc | 05 |  | 01pc | 06 |  | 01pc |
| 07 |  | 02pc | 08 |  | 02pc | 09 |  | 02pc |
| 10 |  | 01pc | 11 |  | 01pc | 12 |  | 03pc |
| 13 |  | 30pc | | | | | | |

HERRAGES - QUINCALLERIE - HARDWARE

| | | | | | |
|----------|---|-----|----------|--|------|
| A |  M6x90mm | x14 | H |  | x1 |
| B |  | x8 | I |  | x4 |
| C |  Ø10x40mm | x22 | J |  | x6 |
| D |  Ø8x40mm | x6 | K |  Ø4,5x30mm | x120 |
| E |  M6x60mm | x6 | | | |
| F |  M6x30mm | x6 | | | |
| G |  Ø7x50mm | x6 | | | |

03

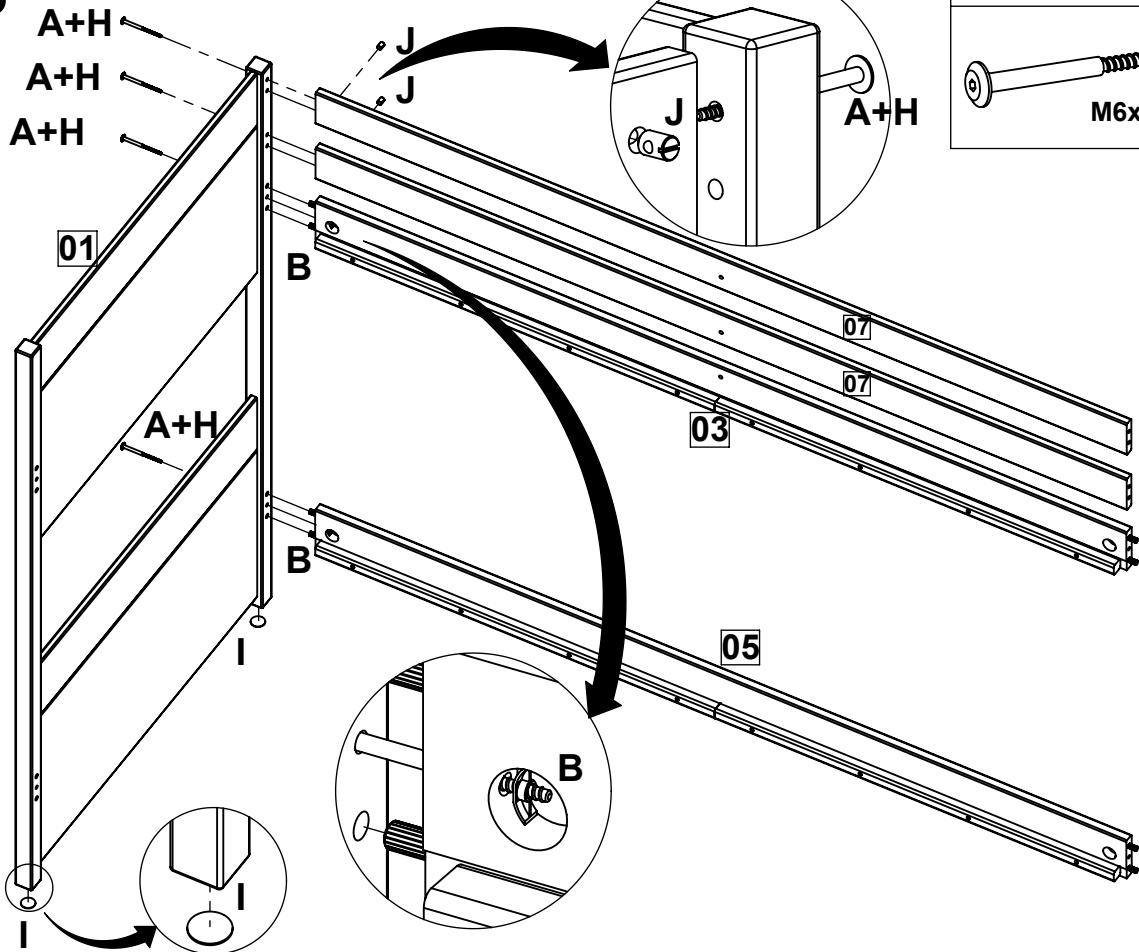

| |
|---|
| Ax4 |
|  |
| M6x90mm |

| |
|---|
| Bx2 |
|  |

| |
|---|
| Jx2 |
|  |

| |
|---|
| Hx1 |
|  |

| |
|---|
| lx2 |
|  |

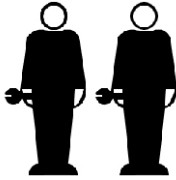

04

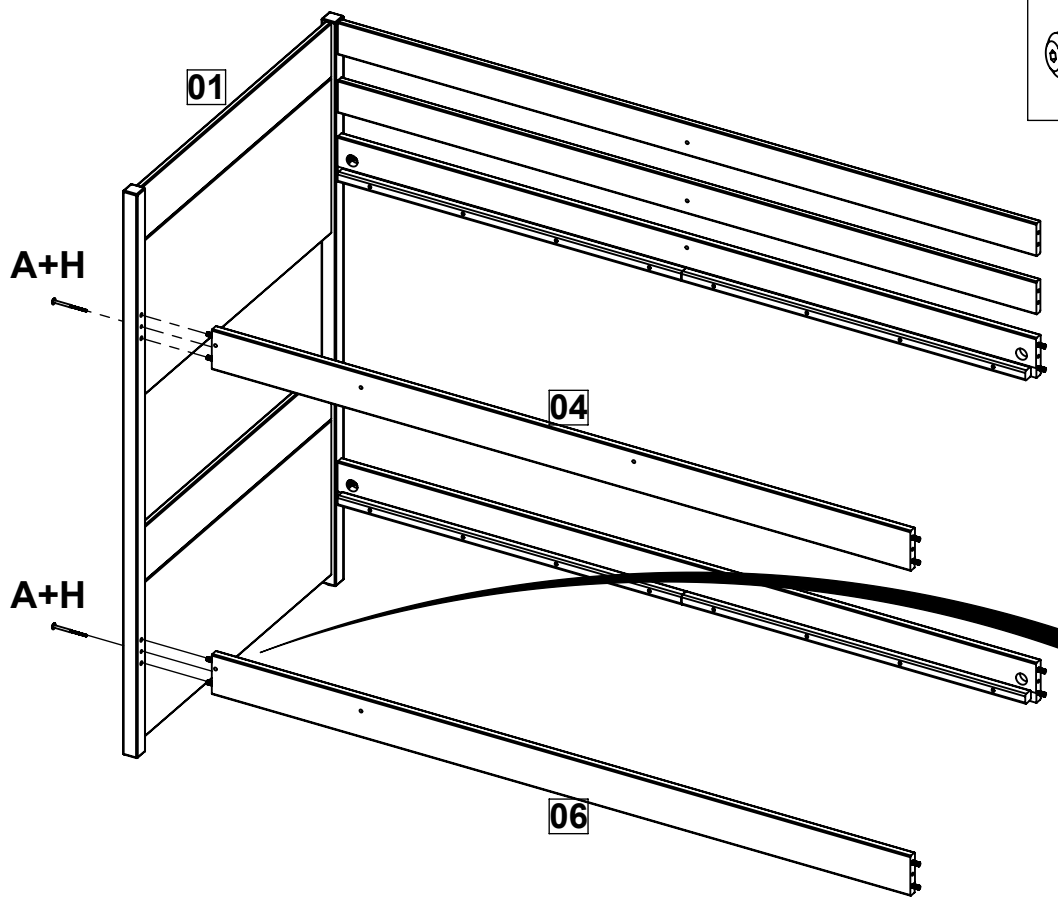

| |
|---|
| Ax2 |
|  |
| M6x90mm |

| |
|---|
| Bx2 |
|  |

| |
|---|
| Hx1 |
|  |

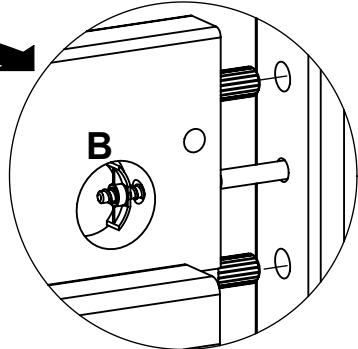
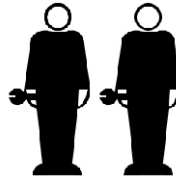

05

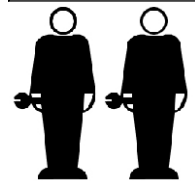
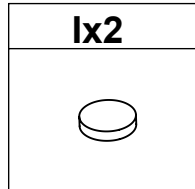
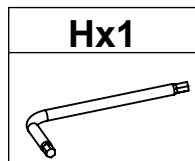
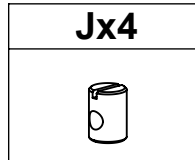
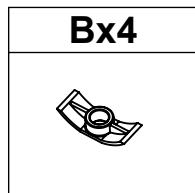
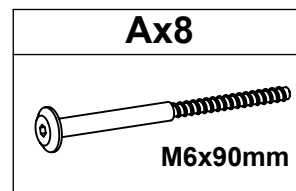
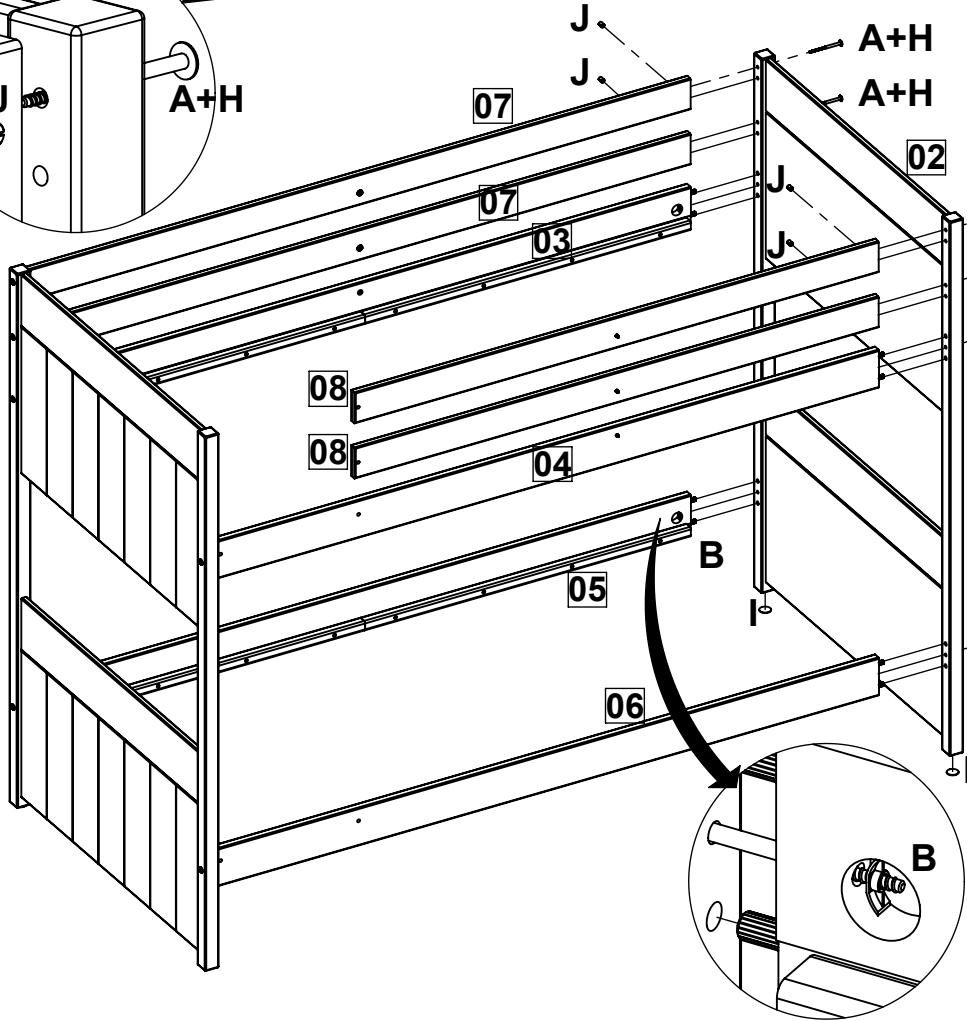
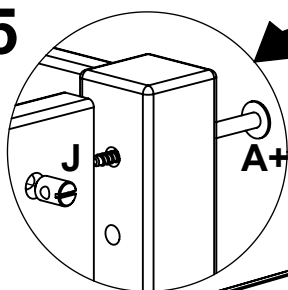

06

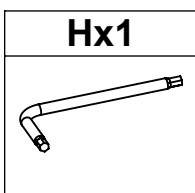
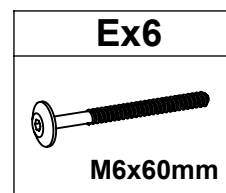
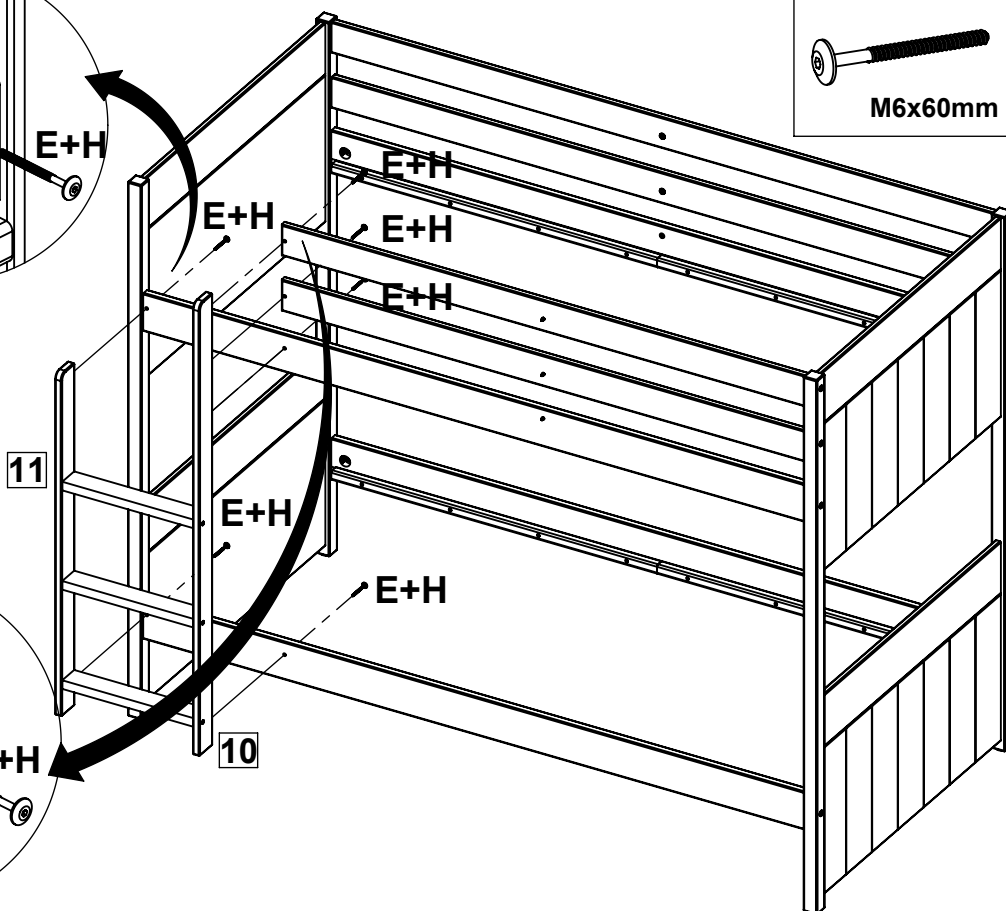
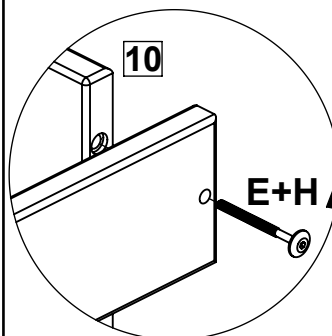
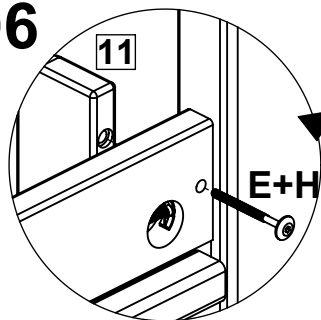

FRANCAIS - SUISSE

CONSEILS DE MONTAGE :

- 1 > BIEN ETUDIER LA NOTICE DE MONTAGE.
- 2 > REPEREZ LES PIECES CONSTITUANT VOTRE MEUBLE.
- 3 > REGROUPEZ ET CONTROLEZ LA QUINCAILLERIE.
- 4 > MUNISSEZ-VOUS DE L'OUTILLAGE NECESSAIRE.
- 5 > AMENAGEZ-VOUS UNE ZONE DE MONTAGE.
- 6 > PROCEDEZ AU MONTAGE.



**NE JAMAIS FORCER LES ASSEMBLAGES.
RESSERREZ LES VIS APRES QUELQUES TEMPS D'USAGE.
GARDER VOTRE NOTICE DE MONTAGE, SI UNE PIECE
VENAIT A MANQUER, ELLE SERAIT LE PLUS CLAIR
MOYEN DE COMMUNIQUER AVEC VOTRE MAGASIN.**

CONSEILS D'ENTRETIEN :

- 1 > DÉPOUSSIÉREZ SOIGNEUSEMENT.
- 2 > UTILISEZ UN CHIFFON SEC.



**- NE JAMAIS UTILISER
DE PRODUITS ABRASIFS:
POUDRE, LAINE D'ACIER, SOLVANTS.
- NE PAS MOUILLER**

| | PAPIER DECOR | SURFACES STRATIFIÉES | SURFACES LAQUÉES | BOIS VERNIS | TEXTILE CUIR |
|--------------------------------|-----------------|-------------------------|---------------------|----------------|-----------------|
| EAU SAVONNEUSE (SAVON NEUTRE) | ○ | ○ | ○ | ○ | ○ |
| EAU ADDITIO NÉE | | ○ | ○ | | |
| ENTRETIEN SPÉCIFIQUE FABRICANT | | | | | ○ |

DEUTSCH - SCHWEIZ

MONTAGE ANLEITUNG:

- 1 > DIE MONTAGEANLEITUNG SORGFÄLTIG DURCHLESEN.
- 2 > DIE EINZELTEILE DES MÖBELSTÜCKS ERMITTELN.
- 3 > DIE BESCHLÄGE ZUSAMMENLEGEN UND PRÜFEN.
- 4 > DAS NOTWENDIGE WERKZEUG ZURECHTLEGEN.
- 5 > EINEN MONTAGEBEREICH FREIMACHEN.
- 6 > DAS MÖBELSTÜCK ZUSAMMENBAUEN.



**NIEMALS DIE VERBINDUNGEN ZU STARK ANZIEHEN.
DIE SCHRAUBEN NACH EINIGER ZEIT DES GEBRAUCHS
ERNEUT FESTZIEHEN. DIE MONTAGEANLEITUNG
GUT AUFBEWAHREN: SOLLTE EIN TEIL FEHLEN, IST SIE DAS
BESTE VERSTÄNDIGUNGSMITTEL MIT IHREM GESCHÄFT.**

PFLEGEHINWEISE :

- 1 > SORGFÄLTIG ENTSTAUBEN.
- 2 > VERWENDEN SIE EIN TROCKENES TUCH.



**- BENUTZEN SIE KEINE
SCHEUERMITTEL WIE PULVER,
STAHLWOLLE, LÖSUNGSMITTEL.
- KEIN WASSER VERWENDEN.**

| | DEKORPAPIER | OBERFLÄCHE LAMINAT | OBERFLÄCHE LACK | LACKIERTEM HOLZ | TEXTIL LEDER |
|----------------------------------|-------------|-----------------------|--------------------|--------------------|-----------------|
| SEIFENLAUGE (NEUTRALSEIFE) | ○ | ○ | ○ | ○ | ○ |
| WASSER MIT HAUSHALTSRFINGER | | ○ | ○ | | |
| PRODUZENT SPEZIFISCHER UNTERHALT | | | | | ○ |

ITALIANO - SVIZZERA

CONSIGLI DI MONTAGGIO

- 1 > STUDIARE BENE LE ISTRUZIONI DI MONTAGGIO.
- 2 > PRENDERE CONOSCENZA DEI PEZZI CHE COSTITUISCONO IL MOBILE.
- 3 > RAGGRUPPARE E CONTROLLARE LA FERRAMENTA.
- 4 > MUNIRSI DEGLI UTENSILI NECESSARI.
- 5 > PREPARARE UNA ZONA DI MONTAGGIO.
- 6 > PROCEDERE AL MONTAGGIO.



**NON FORZARE MAI GLI ASSEMBLAGGI
RISTRINGERE LE VITI DOPO UN PERIODO D'USO
CONSERVARE QUESTE ISTRUZIONI DI MONTAGGIO,
SE UN PEZZO VENISSE A MANCARE SAREBBE IL MIGLIORE
MEZZO DI COMUNICAZIONE CON IL RIVENDITORE**

CONSIGLI PER LA MANUTENZIONE :

- 1 > SPOLVERATE ACCURATAMENTE.
- 2 > USARE UN PANNINO ASCIUTTO.



**- NON UTILIZZARE MAI PRODOTTI
ABRASIVI: POLVERE,
LANA DI ACCIAIO, SOLVENTI.
- NON BAGNARE.**

| | CARTA | SUPERFICIE STRATIFICATE | SUPERFICIE LACCATE | LACCATE EGNO VERNICIATO | TESSILE CUIRO |
|-----------------------------------|-------|----------------------------|-----------------------|----------------------------|------------------|
| ACQUA CON SAPONE (SAPONE NEUTRO) | ○ | ○ | ○ | ○ | ○ |
| ACQUA CON DETERSIVO SAN MARC | | ○ | ○ | | |
| MANUTENZIONE SPECIFICA PRODUTTORE | | | | | ○ |

PORTUGUÊS

CONSELHOS DE MONTAGEM:

- 1 > ESTUDE BEM AS INSTRUÇÕES DE MONTAGEM.
- 2 > REUNA AS PEÇAS QUE CONSTITUEM O SEU MÓVEL.
- 3 > REAGRUPE AS FERRAGENS.
- 4 > EQUIPE-SE COM AS FERRAMENTAS NECESSÁRIAS.
- 5 > PREPARE UMA ÁREA PARA A MONTAGEM.
- 6 > INICIE A MONTAGEM.



**NUNCA FORÇAR OS ENCAIXES.
REAPERTAR OS PARAFUSOS APÓS UM TEMPO DE UTILIZAÇÃO.
GUARDAR AS INSTRUÇÕES DE MONTAGEM.
CASO FALTE ALGUMA PEÇA, O MAIS ACONSELHÁVEL
É CONTATAR O REVENDEDOR.**

CONSELHOS PARA A MANUTENÇÃO :

- 1 > ELIMINAR BEM O PÓ.
- 2 > USAR PANO SECO.



**- NUNCA UTILIZAR PRODUTOS
ABRASIVOS: SAPONÁCEOS,
LÃ DE AÇO, SOLVENTES.
- NÃO MOLHAR .**

| | ACABAMENTO IMITAÇÃO | SUPERFÍCIES ESTRATIFICADAS | SUPERFÍCIES LACADAS | MADEIRA ENVERNIZADA | TEXTEIS PELES |
|--------------------------------------|------------------------|-------------------------------|------------------------|------------------------|------------------|
| ÁGUA COM SABÃO (SABÃO NEUTRO) | ○ | ○ | ○ | ○ | ○ |
| ÁGUA COM DETERGENTE | | ○ | ○ | | |
| INSTRUÇÕES ESPECÍFICAS DO FABRICANTE | | | | | ○ |

ESPAÑOL

CONSEJOS PARA EL MONTAJE:

- 1 > ESTUDIE ATENTAMENTE EL MANUAL DE MONTAJE.
- 2 > LOCALICE LAS PIEZAS QUE CONSTITUYEN SU MUEBLE.
- 3 > REUNA Y CONTROLE LOS TORNILLOS.
- 4 > EQUIPE-SE DE LAS HERRAMIENTAS NECESARIAS.
- 5 > PREPARE UNA ZONA DE MONTAJE.
- 6 > REALICE EL MONTAJE.



**NO FUERCE NUNCA EN LAS UNIONES. APRIETE LOS
TORNILLOS DESPUES DE CIERTO TIEMPO DE UTILIZACION
CONSERVE SU MANUAL DE MONTAJE,
SI FALTARA UNA PIEZA, SERIA LA MANERA
MAS FACIL DE COMUNICAR CON LA TIENDA.**

CONSEJOS PARA EL MANTENIMIENTO:

- 1 > DESPOLVEAR CULDAOSAMENTE.
- 2 > UTILICE UN PAÑO SECO.



**- NO USE NUNCA PRODUCTOS
ABRASIVOS TALES COMO:
POLVO DE LIMPIAR,
LANA DE ACERO, SOLVENTES.
- NO MOJAR.**

| | PAPEL DE DECORACION | SUPERFICIE ESTRATIFICADAS | SUPERFICIE MAQUEADAS | MADERA BARNIZADA | TEXTIL/ CUERO |
|---|------------------------|------------------------------|-------------------------|---------------------|------------------|
| AGUA Y JABON (JABON NEUTRO) | ○ | ○ | ○ | ○ | ○ |
| AGUA COM DETERGENTE | | ○ | ○ | | |
| MANTENIMIENTO ESPECIFICO DEL FABRICANTE | | | | | ○ |

HRVATSKA

UPUTE ZA MONTAŽU:

- 1 > PAŽLJIVO PROČITAJTE UPUTE ZA MONTAŽU.
- 2 > PRIPREMITE SVE DIJELOVE NAMJEŠTAJA.
- 3 > PRIKUPITE I PROVJERITE OKOVE ZA MONTAŽU.
- 4 > PRIPREMITE POTREBAN ALAT.
- 5 > PRIPREMITE PROSTOR ZA MONTAŽU.
- 6 > POČNITE MONTIRATI.



**NEMOJTE UPOTREBLJAVATI SILU PRILIKOM SKLAPANJA
NAKON NEKOG VREMENA PONOVRNO PRITEGNITE VIJKE
ČUVAJTE UPUTE ZA MONTAŽU
U SLUČAJU NEDOSTATKA NEKOG DIJELA NAJBOLJE ĆE BITI DA
DA KONTAKIRATE PRODAJNO MJESTO.**

UPUTE ZA ODRŽAVANJE :

- 1 > PAŽLJIVO OBRISATI PRAŠINU.
- 2 > KORISTITE SUHU KRPU.



**- ZABRANJENA JE UPOTREBA
KEMIKALIJA ILI BILO KAKVIH
POMOĆNIH SREDSTAVA ZA RIBANJE
JAKIH SREDSTAV ZA ČIŠĆENJE ILI
ČELIČNE VUNE
-NE MOKRA.**

| | PAPIR | LAMINAT | LAK | DRVO | TEKSTIL/ KOŽA |
|--------------------|-------|---------|-----|------|------------------|
| OTPINA SAPUNA | ○ | ○ | ○ | ○ | ○ |
| OTPINA DETERĐŽENTA | | ○ | ○ | | |
| NAMJENSKA SREDSTVA | | | | | ○ |

TÜRKÇE

MONTAJ TALİMATLARI:

- 1 > Montaj tanıtım yazısını dikkatlice okuyunuz.
- 2 > Mobilyanızı oluşturan parçaları işaretleyiniz.
- 3 > Hırdavatla ilgili parçaları bir araya toplayıp; kontrol ediniz.
- 4 > Gereken araç ve gereci tedarik ediniz.
- 5 > (Kendinize) Bir montaj alanı edininiz.
- 6 > Monte etmeye başlayınız.



**MONTAJLARI ZORLAMAYINIZ.
BİRKAÇ KULLANIMDAN SONRA VİDALARI SIKIŞTIRINIZ.
BİR PARÇANIN KAYBOLMASI DURUMUNDA MAĞAZANIZLADAKİ
KOLAY İLETİŞİME GEÇEBİLMEZ İÇİN MONTAJ KULLANIM
TALİMATINIZI SAKLAYINIZ.**

BAKIM TALİMATLARI:

- 1 > TOZUNU DİKKATLİCE ALINIZ.
- 2 > YUMUŞAK BİR BEZİ TEMİZ SU VE AZ MİKTARDA SABUNLA(DETERJAN) NEMLENDİRİNİZ.



**- ASLA AŞINDIRICI ÜRÜNLER
KULLANMAYINIZ : ÇELİK YÜNÜ,
SOLVENT...
- BOL SUYLA YIKAMAYINIZ.**

| | SÜS KAĞIDI | KATMAN YÜZEY | LAKE YÜZEY | CİRALI TAHTA | TEKSTİL DERİ |
|-------------------------|---------------|-----------------|---------------|-----------------|-----------------|
| SABUNLU SU (NÖTR SABUN) | ○ | ○ | ○ | ○ | ○ |
| DETERJAN KATILMIŞ SU | | ○ | ○ | | |
| ÜRETİCİYE ÖZGÜ BAKIM | | | | | ○ |

ENGLISH

ASSEMBLY ADVICE :

- 1 > CAREFULLY READ THE ASSEMBLY INSTRUCTION.
- 2 > IDENTIFY THE COMPONENTS OF THE FURNITURE.
- 3 > GROUP AND CHECK THE HARDWARE.
- 4 > USE THE REQUIRED TOOLS.
- 5 > CREATE AN ASSEMBLY ZONE.
- 6 > MAKE THE ASSEMBLY.



**NEVER FORCE THE CONNECTIONS.
RE-TIGHTEN THE SCREWS AFTER FEW DAYS.
PLEASE RETAIN THE AI LEAFLET FOR FUTURE REFERENCE,
THE AI CONTAINS INFORMATION WHEN CLAIMING
FOR MISSING PARTS.**

CLEANING ADVICE:

- 1 > CAREFULLY REMOVE THE DUST.
- 2 > USE A SOFT, CLEAN DAMP CLOTH WITH SOAPY WATER.



**NEVER USE ABRASIVE PRODUCTS
OR SOLVENTS.
DO NOT APPLY EXCESSIVE PRESSURE
WHEN USING THE DAMP CLOTH.**

| | PAPER DECOR | LAMINATED SURFACES | LACQUERED SURFACE | VARNISHED WOOD | LEATHER TEXTILE |
|----------------------------|-------------|-----------------------|----------------------|-------------------|--------------------|
| SOAPY WATER (NEUTRAL SOAP) | ○ | ○ | ○ | ○ | ○ |
| WATER WITH DETERGENT | | ○ | ○ | | |
| SPECIFIC SUPPLIER CLEANING | | | | | ○ |



FRENCH: "Les meubles contenant des panneaux à base de bois (panneaux de particules, panneaux de fibres, contreplaqué...) peuvent émettre des substances polluantes dans l'air intérieur. Il est ainsi recommandé, après l'installation du meuble dans son logement, d'aérer fréquemment la pièce concernée pendant au moins quatre semaines afin de réduire son exposition aux polluants émis par le meuble."

SPANISH: Los muebles que contienen paneles a base de madera (Aglomerado, cartón, contrachapado ...) pueden emitir sustancias contaminantes en el aire. Por lo tanto, se recomienda airear frecuentemente los muebles al menos durante cuatro semanas después de su instalación para reducir su exposición a los contaminantes emitidos por los muebles.

ENGLISH: Furniture containing wood-based panels (Particle board, fibreboard, plywood ...) could emit pollutants on the air. Therefore, it is advisable to ventilate the furniture at least during four weeks after its assembly in order to reduce the exposure to the pollutants released by the furniture.